



SCALING CHARACTERISTICS OF INFLATABLE PARABOLOID CONCENTRATORS

Mitchell Thomas and Gordon Veal
L'Garde, Incorporated
Tustin, California

ABSTRACT

Under a series of contracted analytic and experimental studies, we have been increasing the size of inflated parabolic structures for use in space and determining surface accuracy. The primary user for this technology is the Solar-Powered Rocket, where hydrogen gas is heated to a high temperature by solar energy, rather than chemical or electrical means. To make the solar rocket work, very large (typically 150-ft. diameter), highly-accurate (typically surface accuracy better than 1 mrad slope error), lightweight paraboloids are needed. Based on subscale surface accuracy tests, there is a concern if a full size system can be constructed that meets the accuracy requirements.

An analysis was performed that indicates when absolute error is held nearly constant, the slope error will be greatly reduced as size increases.

A major source of error is the elastic modulus of the plastic film used for the reflector. Modulus data published by the film manufacturers are average values and cannot be used in determining the gore dimensions required to obtain the desired reflector shape. Modulus data as a function of stress is presented.

Tests have been performed on 1 and 3 meter on-axis and 3 meter off-axis parabolas. The results to date indicate that surface shape errors do not increase directly with size. Further work in progress is needed to properly evaluate the scaling of surface error with size.

INTRODUCTION

Parabolic concentrators are needed in space for solar concentrators and microwave antennas. These concentrators must be lightweight, low-cost, and still retain high precision to be of value. Earlier studies [1,2] have shown that inflatable paraboloids offer significant savings in payload weight and packaged volume when compared to paraboloids mechanically erected in space. Leakage through holes caused by meteoroids or manufacturing methods is handled by carrying along sufficient makeup gas to maintain inflation - practical because of the very low pressures needed. For ten years in orbit, such an inflated paraboloid with its make up gas is nominally an order of magnitude lower in weight than competing mechanical systems.

There are other advantages of the inflatable structure. Dynamic performance is improved through rapid damping and non-linear restoring forces. The radiative exchange between the reflector and its canopy completing the balloon structure reduces thermal

gradients by an order of magnitude. The inflatable typically can be packaged into odd shapes, so that volume limitations become a minor constraint. Inflatable devices typically have low development and production costs. These features potentially can reduce the cost of space reflectors by an order of magnitude, making possible space missions otherwise too costly. The challenge is to assure that inflatable paraboloids have sufficiently high efficiency and accuracy to satisfy system requirements.

Pioneering work on inflatable reflectors for space was performed over 25 years ago. Two ten-foot-diameter paraboloids were built and tested for surface accuracy and microwave performance [3]. The absolute rms surface errors were 3.4 mm and 3.8 mm for these two early devices. The authors postulated that with formed membranes, the errors could be reduced to below 1.3 mm rms. Recently, 2.8 m off-axis paraboloids have been built and ground tested and accuracy measured [4]. The accuracy of these has been estimated to be 1 mm rms. The design includes a space rigidization mechanism so that inflating need not be maintained, although this negates some of the inflatable's advantages.

For solar concentrators the key parameter defining the accuracy is the slope error, rather than the absolute error. Hedgepeth [5] shows that the problem of the solar concentrator is somewhat eased by the large (9 mrad) solar source. High concentration ratios can be obtained for rms slope errors as high as 3 mrad. Sundstrand built a large inflatable concentrator that was then rigidized [6], and the measured surface accuracy was about 0.5" (9 mrad) for the 45 ft. diameter system.

In this paper we are presenting a summary of error measurements made on a series of inflated paraboloids, using a laser to trace light rays. This type of setup is only aimed at finding the errors due to gross surface distortions, which is currently the main problem with these devices. Microscopic surface quality is important for solar collectors (although not for microwave frequencies), but highly specular reflectors are readily obtained in many existing thin films. We note, however, that if the surface becomes diffuse because of the type of film or coating used, unacceptable losses in focused energy can occur.

The studies performed under the NASA Antenna Study [2], the HAIR I [7] and HAIR II [8] programs showed that the deviation between a test concentrator and a best-fit paraboloid was systematic. A typical straight cut across a test paraboloid near its midpoint, gave characteristic "W" or "M" patterns such as shown in Figure 1. Similar data have been found for the 1 and 3 meter paraboloids. Theoretical predictions of these deviations has so far been unsuccessful. The pattern may hold only for the inflatables, where a uniform

pressure is the force that forms the membrane which is held at the edges. Mechanical systems can support such segments of a paraboloid in many different ways, so that the deviation curve is not likely to resemble Figure 1.

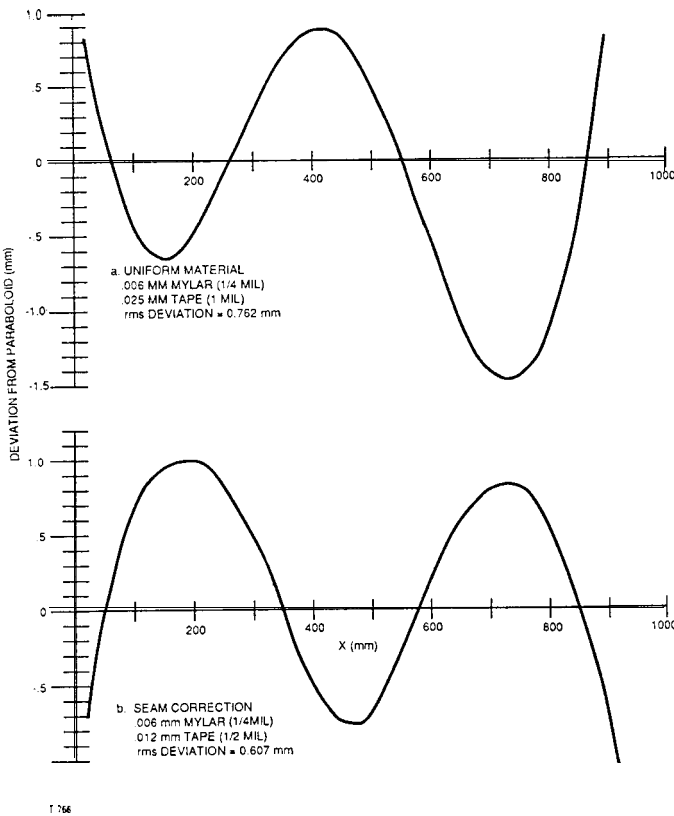
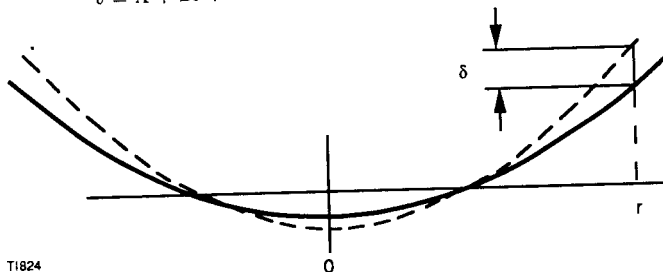

Figure 1. Comparison of Paraboloids Using Two Different Flat Patterns

These data can be used to obtain a general relationship between absolute error and slope error for typical inflatable concentrators. First, we approximate the deviations as being symmetric about the center of the paraboloid. Then we can let the curve describing the deviation as a function of radius from the paraboloid center be

$$\delta = A + Br + Cr^2 + Dr^3 \quad (1)$$



By symmetry, $\left. \frac{d\delta}{dr} \right|_{r=0} = 0$, so that the coefficient $B = 0$. In general, the most rapid change in the paraboloid slope occurs near the boundaries ($r = R$) (suggesting that much distortion is an edge effect), so we will assume that

$$\left. \frac{d\delta}{dr} \right|_{r=R} = 0$$

The results are not expected to be sensitive to this choice of parameter. The absolute error is then given by

$$\delta = A - \frac{9}{8} DRr^2 + Dr^3 \quad (2)$$

For simplicity assume also that the deviation is zero at the paraboloid boundary, so that the best fit paraboloid is constrained to go through the boundary. (Note that this constraint was not used to get the best fit in Figure 1, but if it had been the "W" and "M" shape would have resulted.) Then, the formula becomes

$$(\delta = 0 \text{ for } r = R) \quad (3)$$

$$\delta = D \left[\frac{R^3}{8} - \frac{9}{8} Rr^2 + r^3 \right]$$

The mean square deviation is then given by

$$\langle \delta^2 \rangle = \frac{\int_0^R r d\theta dr \delta^2}{\pi R^2} = \frac{2D^2}{R^2 64} \int_0^R dr r (R^3 - 9Rr^2 + 8r^3)^2$$

or the rms error is

$$\sqrt{\langle \delta^2 \rangle} = \delta_{rms} = 0.0634 DR^3 \quad (4)$$

Similarly, the slope error is given by $\Delta = \frac{d\delta}{dr}$ so that the mean square slope error is

$$\langle \Delta^2 \rangle = \frac{2D^2}{R^2 16} \int_0^R dr r (-9Rr + 12r^2)^2$$

The rms slope deviation is then

$$\Delta_{rms} = 0.36DR^2 \quad (5)$$

Finally, the relationship between the absolute and slope rms errors is given by combining equations (4) and (5):

$$\Delta_{rms} = \frac{5.678}{R} \delta_{rms} \quad (6)$$

For the HAIR II 3-m reflector, the absolute rms error and slope error were 1.15 mm and 3.175 mrad, respectively. Substituting the absolute rms error into equation (6) would predict a slope error of 4.35 mrad. This is off by 37% from the measured value (3.175), but useful in getting a feel of how absolute and slope errors compare.

Note that the formula predicts that as scale (R) increases, if the absolute error can be kept nearly constant, the slope error will be dramatically reduced.

MODULUS DATA

The solar reflectors are constructed by joining a series of flat gores. The gores are shaped such that when stretched by the inflation pressure a parabolic shape results. Small errors in the initial shape of the gores or in the amount the gores stretch will result in an improperly shaped reflector. As a result accurate knowledge of the tensile modulus is necessary. DuPont lists the modulus for type S Mylar as 527,000 psi for the machine (roll) direction and 548,000 psi for the transverse direction. These are average values since the value varies from lot to lot. In addition, we found a significant variation in the modulus as a function of

stress level. This variation with stress level is important since the stress in an inflated paraboloid varies with the distance from the apex.

A typical stress strain curve for the particular roll of 1/4 mil Mylar used on the Deployable Solar Concentrator Experiment (DSCE) program is shown in Figure 2. Five one-inch-wide tensile-test samples were run for the machine or roll direction and five for the transverse direction. The tests were run on a Monsanto tensiometer 10" tensile tester. The head speed was .02 in/min, with the extensometers set at 4 inches. Normal head speed is 100% elongation per minute. The nominal material thickness was 0.25 mil (.00025 in.) the actual thickness of each sample was measured with a micrometer in five places and the results which ranged from 0.24 to 0.27 mil were averaged. The average thickness was 0.26 mil. The average thickness to nominal thickness ratio was used as a stress correction factor in calculating the modulus. For the tensiometer plots (stress vs. strain), the nominal area .00025 in² was input rather than the actual areas which were measured after the test.

Using the stress-strain curves the modulus was calculated for each sample at 2000 psi intervals from 2000 psi to 10000 psi stress levels. The data for the different samples were then averaged and the two curves shown in Figure 3 were plotted. Typical rms deviations are also shown.

These data were then used in the calculation of the gore shape.

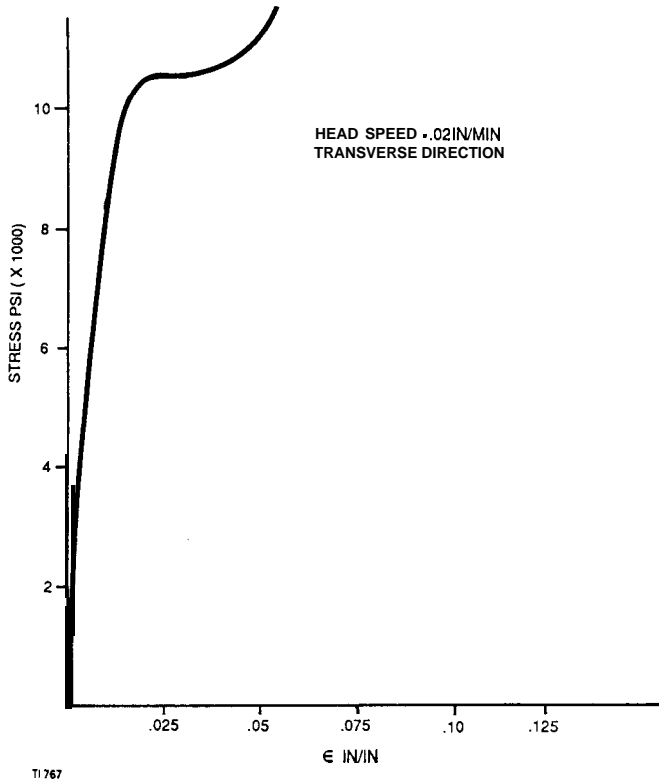

Figure 2. Typical Stress/Strain Curve

TEST RESULTS

The testing and test results discussed in this section were accomplished as part of several programs sponsored by the Air Force Astronautics Laboratory. The inflated surfaces were mapped using a laser and optical bench. The actual test setup varied with reflector configuration but the principle was the same. The experimental setup is shown schematically in Figure 4. An automated data reduction procedure was employed. The data reduction flow chart is shown in Figure 5.

Included in the data reduction code was a method of introducing random measurement uncertainties (around 0.5mm); there was no significant effect on the deduced surface contour.

The tests consisted of two types -- the reflector mounted on a rigid ring and the reflector mounted on an inflatable torus. The tests were accomplished in the following manner. The membrane was aligned with the laser and optical bench. A vacuum was pulled on the

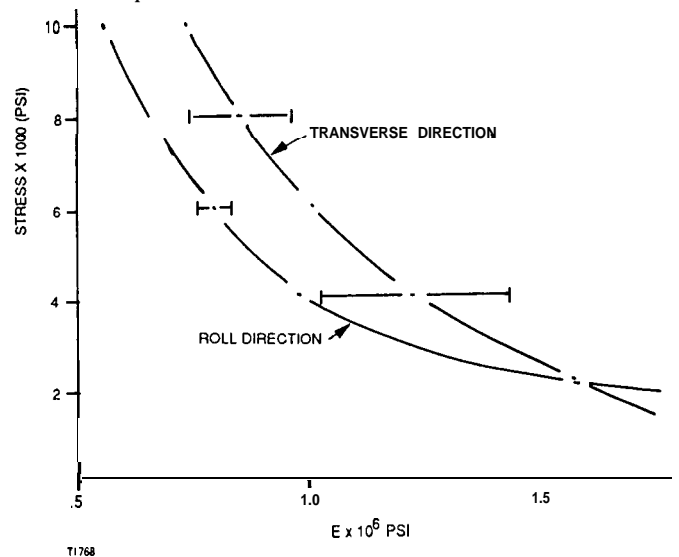

Figure 3. Modulus of Elasticity Dependence on Stress

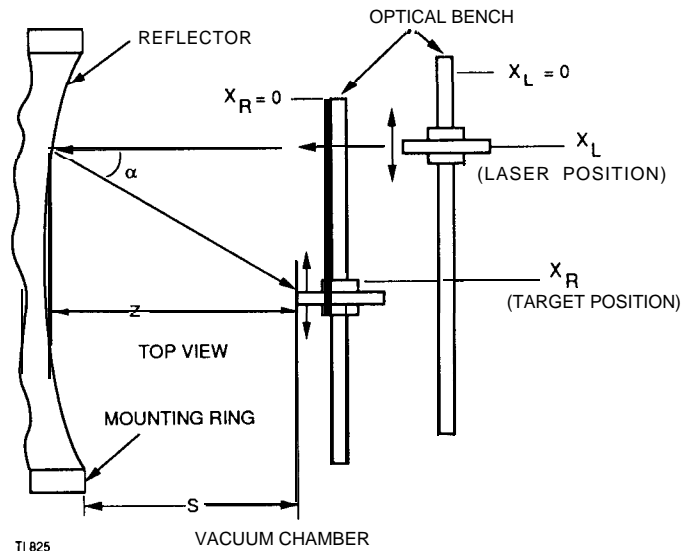

Figure 4. Slope Measurement Optical Setup

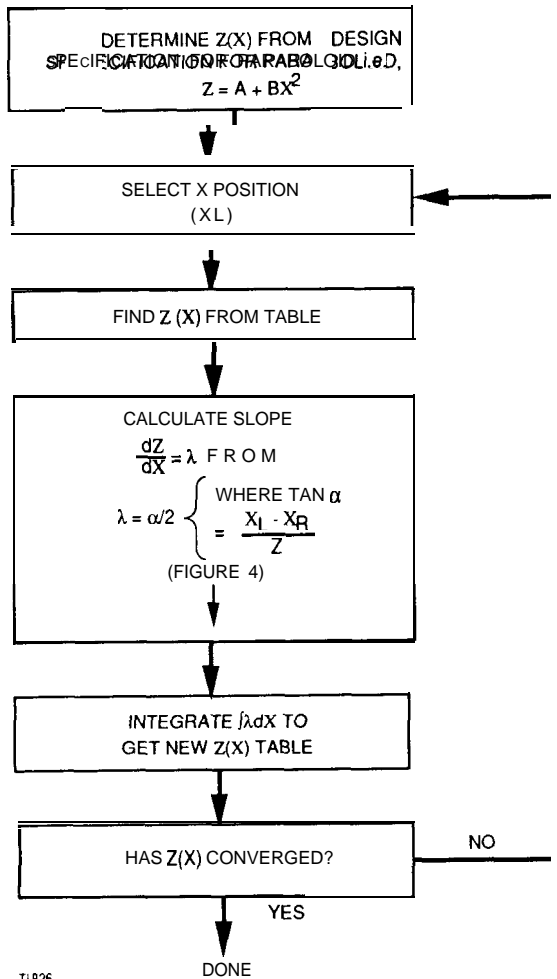

Figure 5. Determining paraboloid Shape by Slope Measurement

membranes mounted on the rigid rings or the membrane assembly was inflated for those mounted on the torus.

Once the desired pressure level was reached and stabilized, the laser was moved in 1 cm increments across the paraboloid. X_l and X_r were recorded for each laser position.

The X_l and X_r data were entered into the data reduction program and the following were calculated: 1) surface deviations from the best fit parabola in millimeters rms, 2) focal length, 3) slope error in milliradians rms. The program also provided plots of surface deviation, slope error and slope. Samples of these plots are shown in Figures 6, 7 and 8.

The best (highest accuracy) results from these tests are as follows:

Rigid Ring Suoorted

1 meter on-axis [8]	.35 mm RMS
3 meter on-axis [8]	1.15 mm RMS (3.175 mrad)
2 x 3 meter off-axis	.75 mm RMS (2.73 mrad)

Inflated Torus Suoorted

2 x 3 meter off-axis	.60 mm RMS (3.230 mrad)
----------------------	-------------------------

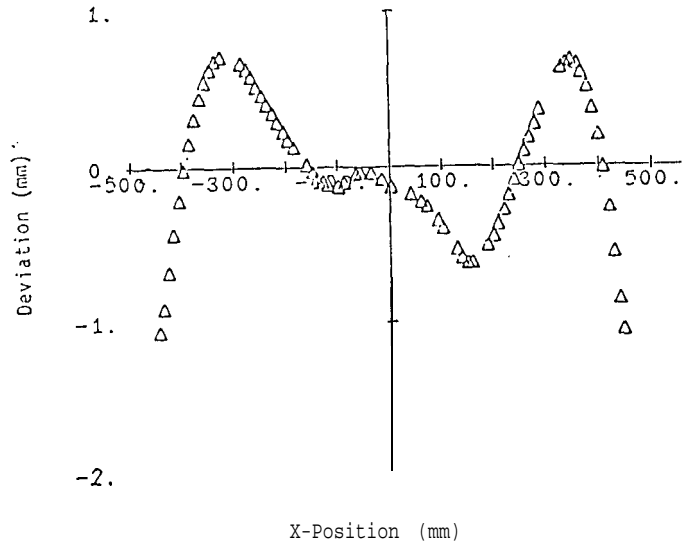

Figure 6. Typical Surface Deviation Plot

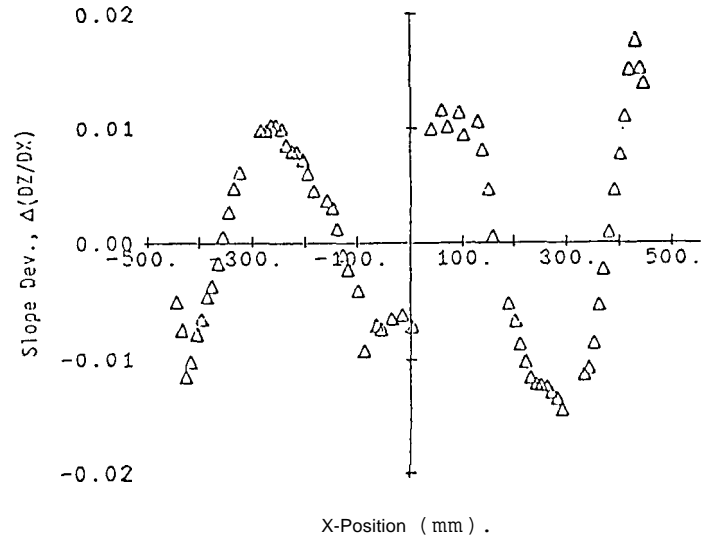

Figure 7. Typical Slope Deviation Plot

SENSITIVITY ANALYSIS

The experiments performed have indicated that small variations in pressure, modulus, or seam accuracy can significantly affect focal length. A simplified analysis was performed to get a feel for the importance of this effect. The off-axis paraboloids may be approximated by a circular section along any cut by a plane perpendicular to the plane of the ellipse. There is then a definite geometric relation between the material length, the inflation pressure, and the focal length, or radius of curvature.

Figure 9 defines the parameters. In this section, r is the radius of curvature, s is the material stretched length, y is the distance from the edge of the ellipse to the center, and x is the depth of the paraboloid below the plane of the ellipse. Also, let s_0

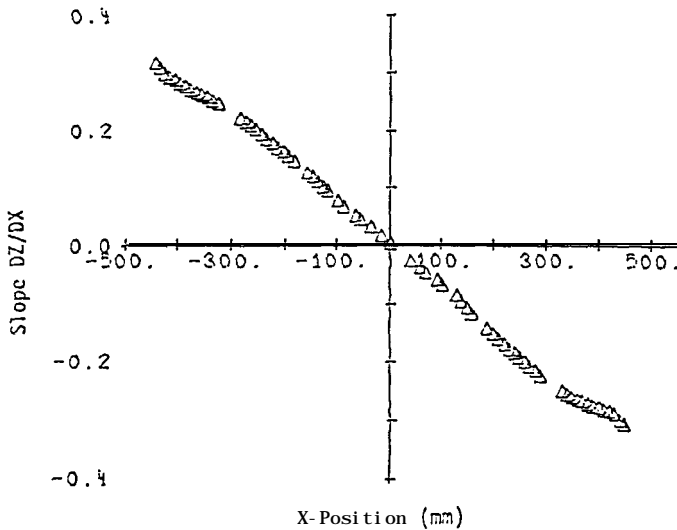

Figure 8. Typical Slope Plot

be the original, unstretched membrane length and s be the amount stretched. Then for a circular segment, the change in length is given by

$$\frac{\Delta s}{s_0} = \frac{(1 - \nu)Pr}{Et} \quad (7)$$

Also, $y = r \sin \theta$ and $s = 2r\theta$. It can then be shown that

$$\sin \theta = \frac{2xy}{x^2 + y^2} \text{ and } s = s_0 + \Delta s = \frac{2y\theta}{\sin \theta}$$

Also using (7)

$$\frac{s}{s_0} - 1 = \frac{(1 - \nu)rP}{Et} \quad \text{or} \quad P = \frac{Et \sin \theta}{(1 - \nu)y} \left(\frac{s}{s_0} - 1 \right)$$

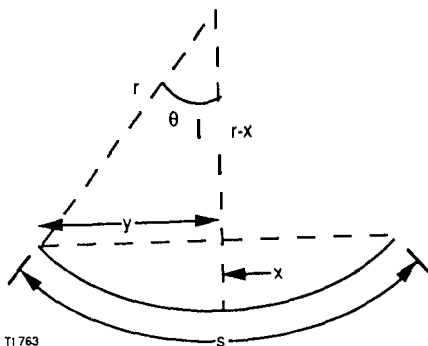

Figure 9. Parameters Used in Approximate Model

These equations can be solved for three parameters θ , s , and P for a given x and a constant s_0 . Calculations were performed for $s_0 = 78.74364$ in, $\nu = 0.3$, $y = 39.37$, $t = 0.00025$ mil, and $E = 677,000$ psi. Figure 10 shows the dependence of paraboloid depth upon inflation pressure.

The question can be asked, "What pressure is needed to obtain the required depth x if the initial length is not right?" Figure 11 shows the results of these calculations for a variation in initial length and x set at 7.92 cm. The effect is seen to be linear, with a 0.1 in. shortness requiring a AP of 0.177 psf to compensate.

These data show that for typical designs, high precision in manufacturing is essential to producing highly accurate paraboloids.

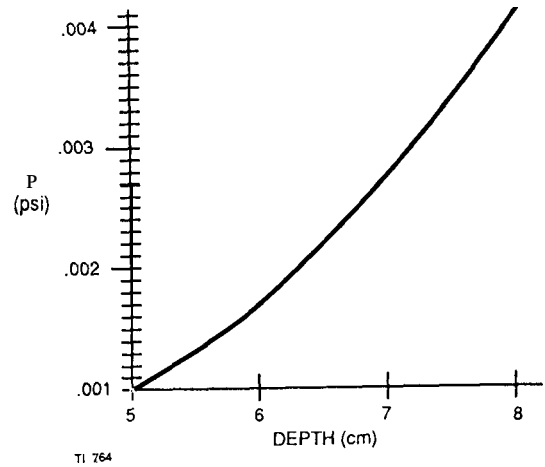

Figure 10. Pressure Effect, on Paraboloid Depth

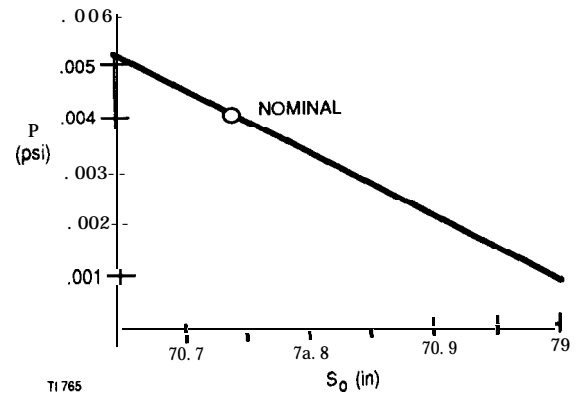

Figure 11. Effect of Manufactured Length

A similar result obtains for variations in modulus. The data of Figure 3 showing strain-dependent values of the modulus was used to compute the optimum pressure and resulting flat pattern for a 2×3 m off-axis paraboloid. The paraboloid had 8 gores and focal length of 3.18 m. This was compared with the calculation for a constant modulus of 500,000 psi. The results are significantly different. The pressure for the optimum inflation in the first case of 0.332 psf and in the second case is 0.748 psf. The flat patterns for the two cases were nearly the same. The maximum length was 118.12 in. in the first case and 118.19 in. for the second case.

These data show that to accurately predict the required inflation pressure for inflated paraboloids very accurate measurements of modulus of elasticity are needed. Because, however, of the insensitivity of the resulting optimum flat pattern, to the modulus of paraboloid accuracy can be improved after construction. A highly accurate paraboloid can be obtained using active measurement of paraboloid depth, focus, or other parameter to adjust the inflation pressure during deployment.

CONCLUSIONS

The deviations of test inflatable paraboloids from best-fit paraboloids is systematic. The functional shape of the deviation as a function of position across the paraboloid has been shown to be the same for 1 and 3 meter diameter paraboloids. The implication is that the paraboloid slope error will be related to the absolute error by a constant divided by the paraboloid diameter. Thus, if the absolute error can be held constant, the slope error will decrease as the paraboloid's size increases. Further work is needed to extend this analysis to off-axis paraboloids and to include test data from larger paraboloids when it becomes available.

For properly designing an inflated paraboloid, accurate modulus data is essential. Plastic film modulus has been shown to be a strong function of stress, and this variation must be considered during design. If improperly designed, an inflated paraboloid can still be corrected by adjustment of inflation pressure, although system performance will be reduced.

Changing from a rigid mounting ring to an inflatable torus on the 2 x 3 m off-axis paraboloid had a minimal effect on accuracy.

REFERENCES

1. M. Thomas and G. J. Friese, "Pressurized Antennas for Space Radars." from AIAA Collection CP807, from 'the AIAA Sensor Systems for the 80's Conference, December, 1980.
2. G. J. Friese, G. D. Bilyeu, and M. Thomas, Initial '80's Development of Inflated Antennas, L'Garde Report LTR-82-GF-107, NASA Contractor's Report, December 1982.
3. A. J. Wendt and L. D. Surber, "Inflatable Antennas," 3rd Aerospace Expandable and Modular Structures Conference, AFAPL TR 68-17, May 1967.
4. M. C. Bernasconi and G. G. Reibaldi, "Inflatable, Space-Rigidized Structures: -Overview of Applications and Their Technology Impact." IAF Paper IAF 85-210, presented at the 36th Congress of the International Astronautical Federation, October 1985, reprint from AIAA Technical Information Service, A86-15747.
5. J. H. Hedgepeth and R. K. Miller, "Structural Concepts for Large Solar Concentrators," IAF Paper IAF-86-202, presented at the 37th Conoress of the International Astronautical Federation, October 1986, Pergamon Press, Oxford.

6. Brian G. Johnson, "Sundstrand Corporation Experience with Solar Dynamic Power System Concentrators," presented at the Solar Dynamic Power Systems Workshoo Part II, Collection and Thermal Storage, August 1984, NASA Johnson Space Center, Wilson M. Fraser, Jr., Workshop Chairman.
7. M. Thomas and G. Veal, Highly Accurate Inflatable Reflectors. Phase I, L'Garde Report LTR-84-MT-103, March 1984.
8. G. R. Veal, Highly Accurate Inflatable Reflectors. Phase II, AFRPL Report TR-86-089, March 1987.